

# 315C/315C L Hydraulic Excavators

## Dimensions

All dimensions are approximate.

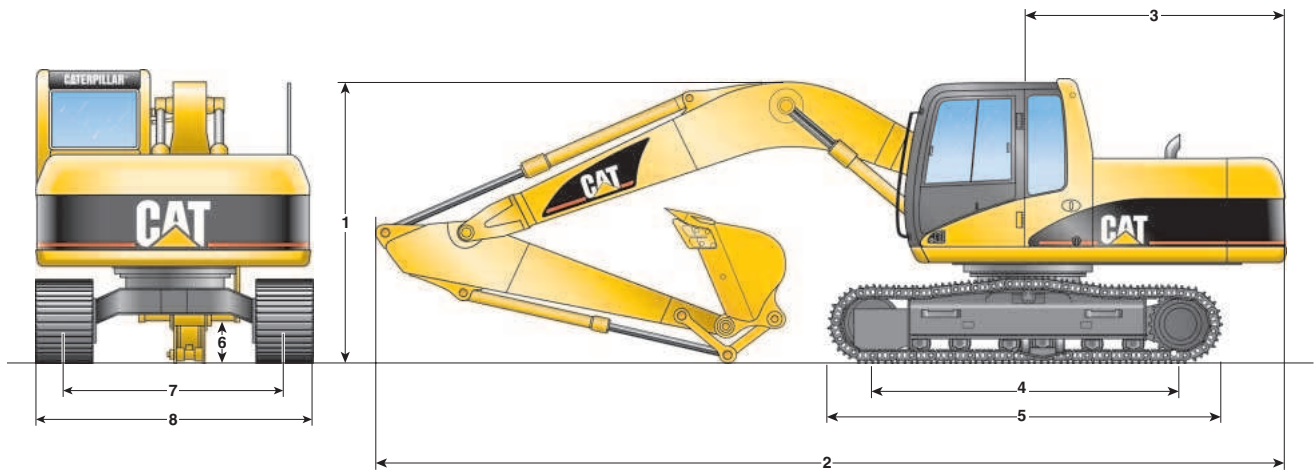

	2250 mm (7'5") Stick	2600 mm (8'6") Stick	3100 mm (10'2") Stick
<b>1</b> Shipping height	2880 mm (9'5")	2880 mm (9'5")	2990 mm (9'10")
<b>2</b> Shipping length	8470 mm (27'10")	8500 mm (27'11")	8520 mm (28'0")
<b>3</b> Tail swing radius	2450 mm (8'0")	2450 mm (8'0")	2450 mm (8'0")
<b>4</b> Length to centers of rollers			
315C	2880 mm (9'5")	2880 mm (9'5")	2880 mm (9'5")
315C L	3170 mm (10'5")	3170 mm (10'5")	3170 mm (10'5")
<b>5</b> Track length			
315C	3690 mm (12'1")	3690 mm (12'1")	3690 mm (12'1")
315C L	3970 mm (13'0")	3970 mm (13'0")	3970 mm (13'0")
<b>6</b> Ground clearance	460 mm (18")	460 mm (18")	460 mm (18")
<b>7</b> Track gauge	1990 mm (6'6")	1990 mm (6'6")	1990 mm (6'6")
<b>8</b> Transport width	with 500 mm (20") 2490 mm (8'2")	with 600 mm (24") 2590 mm (8'6")	with 700 mm (28") 2690 mm (8'10")

# 315C/315C L Hydraulic Excavators

## Working Ranges

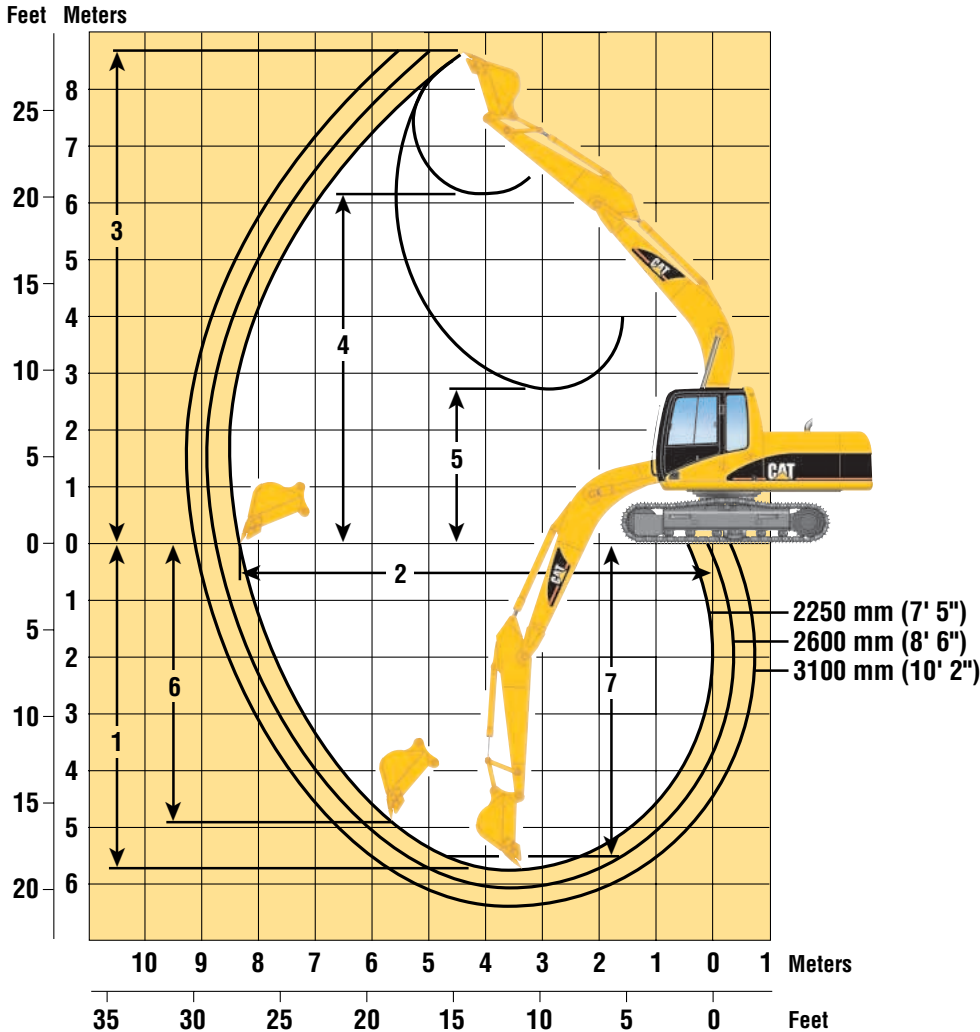

Stick Length	2250 mm (7'5") Stick	2600 mm (8'6") Stick	3100 mm (10'2") Stick
<b>1</b> Maximum Digging Depth	5705 mm (18'9")	6055 mm (19'10")	6555 mm (21'6")
<b>2</b> Maximum Reach at Ground Level	8420 mm (27'7")	8740 mm (28'8")	9140 mm (30'0")
<b>3</b> Maximum Cutting Height	8735 mm (28'8")	8910 mm (29'3")	8970 mm (29'5")
<b>4</b> Maximum Loading Height	6150 mm (20'2")	6320 mm (20'9")	6410 mm (21'0")
<b>5</b> Minimum Loading Height	2690 mm (8'10")	2340 mm (7'8")	1840 mm (6'0")
<b>6</b> Maximum Depth Cut for 2440 mm (8') Level Bottom	5455 mm (17'11")	5825 mm (19'1")	6330 mm (20'9")
<b>7</b> Maximum Vertical Wall Digging Depth	4930 mm (16'2")	5335 mm (17'6")	5570 mm (18'3")
Stick Digging Force (SAE)	84 kN (18,880 lb)	76 kN (17,080 lb)	68 kN (15,280 lb)
Bucket Digging Force (SAE)	99 kN (22,250 lb)	99 kN (22,250 lb)	99 kN (22,250 lb)

# 315C/315C L Hydraulic Excavators

## Buckets

Buckets have tapered sides, angled corner teeth, dual radius curvature, horizontal wear strips, and holes for optional side cutters.

### Excavation Bucket

Width		Capacity		Number of Teeth	Weight with Teeth		Tip Radius	
mm	in	m <sup>3</sup>	yd <sup>3</sup>		kg	lb	mm	in
610	24	0.33	0.43	3	423	933	1340	53
760	30	0.46	0.60	4	480	1058	1340	53
910	36	0.59	0.78	5	538	1186	1340	53
1070	42	0.73	0.95	6	583	1285	1340	53
1220	48	0.86	1.13	6	641	1413	1340	53

Width		Capacity		Short Stick		Medium Stick		Long Stick	
mm	in	m <sup>3</sup>	yd <sup>3</sup>	kg/m <sup>3</sup>	lb/yd <sup>3</sup>	kg/m <sup>3</sup>	lb/yd <sup>3</sup>	kg/m <sup>3</sup>	lb/yd <sup>3</sup>
610	24	0.33	0.43	1800	3000	1800	3000	1800	3000
760	30	0.46	0.60	1800	3000	1800	3000	1800	3000
910	36	0.59	0.78	1800	3000	1800	3000	1800	3000
1070	42	0.73	0.95	1800	3000	1700	2850	1400	2350
1220	48	0.86	1.13	1500	2500	1300	2150	1100	1850

### Heavy Duty Rock Bucket

Width		Capacity		Number of Teeth	Weight with Teeth		Tip Radius	
mm	in	m <sup>3</sup>	yd <sup>3</sup>		kg	lb	mm	in
620	24	0.33	0.43	3	490	1080	1340	53
770	30	0.46	0.60	4	562	1239	1340	53
930	36	0.59	0.78	5	636	1402	1340	53
1080	42	0.73	0.95	6	693	1528	1340	53
1230	48	0.86	1.13	6	766	1689	1340	53

Width		Capacity		Short Stick		Medium Stick		Long Stick	
mm	in	m <sup>3</sup>	yd <sup>3</sup>	kg/m <sup>3</sup>	lb/yd <sup>3</sup>	kg/m <sup>3</sup>	lb/yd <sup>3</sup>	kg/m <sup>3</sup>	lb/yd <sup>3</sup>
620	24	0.33	0.43	1800	3000	1800	3000	1800	3000
770	30	0.46	0.60	1800	3000	1800	3000	1800	3000
930	36	0.59	0.78	1800	3000	1800	3000	1700	2850
1080	42	0.73	0.95	1700	2850	1500	2500	1200	2000
1230	48	0.86	1.13	1400	2350	1200	2000	1000	1650

### Material Densities

Material	kg/m <sup>3</sup>	lb/yd <sup>3</sup>	Material	kg/m <sup>3</sup>	lb/yd <sup>3</sup>
Clay, dry	1480	2500	Gravel, pit run	1930	3250
Clay, wet	1660	2800	Rock/dirt, 50%	1720	2900
Earth, dry	1510	2550	Sand, dry	1420	2400
Earth, wet	1600	2700	Sand, wet	1840	3100
Loam	1250	2100	Sand & Clay	1600	2700
Gravel, dry	1510	2550	Stone, crushed	1600	2700
Gravel, wet	2020	3400	Top soil	950	1600

# 315C/315C L Hydraulic Excavators

## Operating Weights

Caterpillar designed and built track-type undercarriage.

Track Width		Operating Weight (Short Stick)	Operating Weight (Medium Stick)	Operating Weight (Long Stick)
315C	500 mm (20") triple grouser	16 100 kg (35,500 lb)	16 090 kg (35,470 lb)	16 170 kg (35,650 lb)
	600 mm (24") triple grouser	16 320 kg (35,980 lb)	16 310 kg (35,960 lb)	16 400 kg (36,160 lb)
	700 mm (28") triple grouser	16 520 kg (36,420 lb)	16 510 kg (36,400 lb)	16 600 kg (36,600 lb)
315C L	500 mm (20") triple grouser	16 430 kg (36,220 lb)	16 470 kg (36,310 lb)	16 510 kg (36,400 lb)
	600 mm (24") triple grouser	16 680 kg (36,770 lb)	16 710 kg (36,840 lb)	16 750 kg (36,930 lb)
	700 mm (28") triple grouser	16 890 kg (37,240 lb)	16 920 kg (37,300 lb)	16 970 kg (37,410 lb)

## Undercarriage

Caterpillar designed and built track-type undercarriage.

Track Width	Ground Pressure	
	315C	315C L
500 mm (20") triple grouser	50 kPa (7.25 psi)	47 kPa (6.82 psi)
600 mm (24") triple grouser	42 kPa (6.10 psi)	39 kPa (5.66 psi)
700 mm (28") triple grouser	36 kPa (5.22 psi)	34 kPa (4.93 psi)

# 315C/315C L Hydraulic Excavators

## Reach Boom Lift Capacities

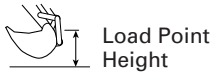

Load Point Height



Load at Maximum Reach



Load Radius Over Front















Load Radius Over Side

**R2.25 STICK** – 2250 mm (7'5")  
**BUCKET** – 0.73 m<sup>3</sup> (0.95 yd<sup>3</sup>)

**UNDERCARRIAGE** – Standard  
**SHOES** – 500 mm (20") triple grouser

**BOOM** – 5100 mm (16'9")















	1.5 m (5.0 ft)		3.0 m (10.0 ft)		4.5 m (15.0 ft)		6.0 m (20.0 ft)				m ft	
												
7.5 m 25.0 ft	kg lb									*1950 *4350	*1950 *4350	5.81 18.57
6.0 m 20.0 ft	kg lb						*2600 *5650	*2600 *5650	*1800 *3900	*1800 *3900		7.16 23.27
4.5 m 15.0 ft	kg lb				*4250 *9200	*4250 *9200	*3900 8450	2700 5800	*1750 *3800	1650 3650		7.90 25.83
3.0 m 10.0 ft	kg lb		*8650 *18,300	7950 17,150	*5500 *11,850	4200 9000	3850 8200	2600 5550	*1800 *3950	1450 3200		8.23 26.99
1.5 m 5.0 ft	kg lb				5850 12,500	3850 8250	3700 7900	2450 5250	*1950 *4300	1400 3100		8.22 26.98
Ground Line	kg lb		*5450 *12,550	*5450 *12,550	5600 12,000	3650 7800	3550 7600	2350 5000	*2250 *4900	1500 3300		7.87 25.81
-1.5 m -5.0 ft	kg lb	*5250 *11,750	*5250 *11,750	*9500 *21,750	6800 14,600	5500 11,850	3550 7650	3500 7550	2300 4900	2750 6000	1800 3950	7.12 23.30
-3.0 m -10.0 ft	kg lb	*9600 *21,550	*9600 *21,550	*10,050 *21,700	7000 15,000	5600 12,000	3650 7800			*3150 *6800	2550 5750	5.79 18.80
-4.5 m -15.0 ft	kg lb			*7000 *15,400	*7000 *15,400					*5000 *11,300	4500 10,750	4.08 12.70

\* Limited by hydraulic capacity rather than tipping load. The above loads are in compliance with SAE hydraulic excavator lift capacity rating standard J1097. They do not exceed 87% of hydraulic lifting capacity or 75% of tipping capacity. Weight of all lifting accessories must be deducted from the above lifting capacities.

**R2.6 STICK** – 2600 mm (8'6")  
**BUCKET** – 0.59 m<sup>3</sup> (0.78 yd<sup>3</sup>)

**UNDERCARRIAGE** – Standard  
**SHOES** – 500 mm (20") triple grouser

**BOOM** – 5100 mm (16'9")

	1.5 m (5.0 ft)		3.0 m (10.0 ft)		4.5 m (15.0 ft)		6.0 m (20.0 ft)		7.5 m (25.0 ft)				m ft
													
7.5 m 25.0 ft	kg lb										*1700 *3750	*1700 *3750	6.28 20.16
6.0 m 20.0 ft	kg lb						*3100 *6250	2900 6200			*1550 *3400	*1550 *3400	7.53 24.49
4.5 m 15.0 ft	kg lb						*3650 *7950	2800 5950			*1500 *3300	*1500 *3300	8.23 26.91
3.0 m 10.0 ft	kg lb		*7700 *16,350	*7700 *16,350	*5150 *11,100	4300 9200	3900 8350	2650 5700	2650 *5550	1750 3750	*1600 *3450	1400 3050	8.55 28.03
1.5 m 5.0 ft	kg lb		*5600 *13,500	*5600 *13,500	5900 12,700	3900 8400	3750 8000	2500 5350	2550 5500	1700 3600	*1700 *3750	1350 2950	8.54 28.02
Ground Line	kg lb		*5950 *13,700	*5950 *13,700	5650 12,100	3650 7850	3600 7700	2400 5100	2500 5500	1650 3600	*1950 *4300	1400 3100	8.20 26.91
-1.5 m -5.0 ft	kg lb	*4900 *11,000	*4900 *11,000	*9050 *20,600	6800 14,500	5500 11,850	3550 7650	3500 7550	2300 4950		*2400 *5300	1650 3600	7.49 24.53
-3.0 m -10.0 ft	kg lb	*8500 *19,050	*8500 *19,050	*10,600 *22,850	6900 14,800	5550 11,900	3600 7750	3550 7650	2350 5050		*3350 *7450	2250 5050	6.26 20.37
-4.5 m -15.0 ft	kg lb			*8050 *17,050	7250 15,550	*5200 *11,500	3800 8350				*4950 *10,850	3650 8250	4.65 14.92

\* Limited by hydraulic capacity rather than tipping load. The above loads are in compliance with SAE hydraulic excavator lift capacity rating standard J1097. They do not exceed 87% of hydraulic lifting capacity or 75% of tipping capacity. Weight of all lifting accessories must be deducted from the above lifting capacities.

# 315C/315C L Hydraulic Excavators

## Reach Boom Lift Capacities

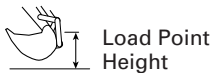

Load Point Height



Load at Maximum Reach



Load Radius Over Front



Load Radius Over Side















**R3.1 STICK** – 3100 mm (10'2")

**BUCKET** – 0.59 m<sup>3</sup> (0.78 yd<sup>3</sup>)

**UNDERCARRIAGE** – Standard

**SHOES** – 500 mm (20") triple grouser

**BOOM** – 5100 mm (16'9")

	1.5 m (5.0 ft)		3.0 m (10.0 ft)		4.5 m (15.0 ft)		6.0 m (20.0 ft)		7.5 m (25.0 ft)				m ft	
														
7.5 m 25.0 ft	kg lb											*1400 *3150	*1400 *3150	6.85 22.07
6.0 m 20.0 ft	kg lb							*2850 *6250	*2850 *6250			*1300 *2900	*1300 *2900	7.98 26.01
4.5 m 15.0 ft	kg lb							*3250 *7050	2850 6050	*2350 *4500	1850 3900	*1300 *2850	*1300 *2850	8.64 28.27
3.0 m 10.0 ft	kg lb			*6350 *13,950	*6350 *13,950	*4550 *9850	4350 9400	*3850 *8300	2700 5750	2650 5650	1750 3750	*1350 *3000	1250 2750	8.94 29.32
1.5 m 5.0 ft	kg lb			*9700 *21,250	7400 15,950	5950 12,800	3950 8500	3750 8000	2500 5350	2550 5450	1700 3550	*1500 *3250	1200 2650	8.93 29.32
Ground Line	kg lb			*6950 *15,900	6800 14,650	5650 12,100	3650 7850	3550 7650	2350 5000	2500 5300	1600 3400	*1750 *3800	1250 2750	8.62 28.27
-1.5 m -5.0 ft	kg lb	*4700 *10,450	*4700 *10,450	*8850 *20,100	6700 14,300	5450 11,700	3500 7550	3450 7450	2250 4850	2450 5350	1550 3450	*2150 *4700	1450 3150	7.95 26.04
-3.0 m -10.0 ft	kg lb	*7500 *16,850	*7500 *16,850	*11,100 *23,950	6750 14,450	5450 11,700	3500 7500	3450 7450	2250 4800			2900 6450	1900 4200	6.82 22.23
-4.5 m -15.0 ft	kg lb	*11,400 *25,800	*11,400 *25,800	*9100 *19,450	7000 15,050	5600 12,050	3650 7800					*2850 *6900	*2850 *6900	4.92 15.81

\* Limited by hydraulic capacity rather than tipping load. The above loads are in compliance with SAE hydraulic excavator lift capacity rating standard J1097. They do not exceed 87% of hydraulic lifting capacity or 75% of tipping capacity. Weight of all lifting accessories must be deducted from the above lifting capacities.













**R2.25 STICK** – 2250 mm (7'5")

**BUCKET** – 0.73 m<sup>3</sup> (0.95 yd<sup>3</sup>)

**UNDERCARRIAGE** – Long

**SHOES** – 600 mm (24") triple grouser

**BOOM** – 5100 mm (16'9")

	1.5 m (5.0 ft)		3.0 m (10.0 ft)		4.5 m (15.0 ft)		6.0 m (20.0 ft)				m ft	
												
7.5 m 25.0 ft	kg lb									*1950 *4350	*1950 *4350	5.81 18.57
6.0 m 20.0 ft	kg lb							*2600 *5650	*2600 *5650	*1800 *3900	*1800 *3900	7.16 23.27
4.5 m 15.0 ft	kg lb					*4250 *9200	*4250 *9200	*3900 *8500	2800 6000	*1750 *3800	1700 3800	7.90 25.83
3.0 m 10.0 ft	kg lb			*8650 *18,300	8200 17,700	*5500 *11,850	4350 9300	*4400 *9550	2700 5750	*1800 *3950	1550 3350	8.23 26.99
1.5 m 5.0 ft	kg lb					*6800 *14,600	4000 8550	4350 9300	2550 5450	*1950 *4300	1500 3250	8.22 26.98
Ground Line	kg lb			*5450 *12,550	*5450 *12,550	6700 14,350	3750 8100	4200 9050	2450 5200	*2250 *4900	1550 3450	7.87 25.81
-1.5 m -5.0 ft	kg lb	*5250 *11,750	*5250 *11,750	*9500 *21,750	7050 15,100	6600 14,150	3700 7950	4150 8950	2400 5150	*2750 *6100	1850 4100	7.12 23.30
-3.0 m -10.0 ft	kg lb	*9600 *21,550	*9600 *21,550	*10,050 *21,700	7250 15,500	6700 14,350	3750 8100			*3150 *6800	2650 5950	5.79 18.80
-4.5 m -15.0 ft	kg lb			*7000 *15,400	*7000 *15,400					*5000 *11,300	4650 11,150	4.08 12.70

\* Limited by hydraulic capacity rather than tipping load. The above loads are in compliance with SAE hydraulic excavator lift capacity rating standard J1097. They do not exceed 87% of hydraulic lifting capacity or 75% of tipping capacity. Weight of all lifting accessories must be deducted from the above lifting capacities.

# 315C/315C L Hydraulic Excavators

## Reach Boom Lift Capacities

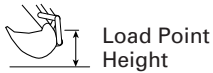

Load Point Height



Load at Maximum Reach



Load Radius Over Front



Load Radius Over Side















**R2.6 STICK** – 2600 mm (8'6")

**BUCKET** – 0.73 m<sup>3</sup> (0.95 yd<sup>3</sup>)

**UNDERCARRIAGE** – Long

**SHOES** – 600 mm (24") triple grouser

**BOOM** – 5100 mm (16'9")

	1.5 m (5.0 ft)		3.0 m (10.0 ft)		4.5 m (15.0 ft)		6.0 m (20.0 ft)		7.5 m (25.0 ft)				m ft	
														
7.5 m 25.0 ft	kg lb											*1650 *3650	*1650 *3650	6.28 20.16
6.0 m 20.0 ft	kg lb						*2900 *5900	*2900 *5900				*1500 *3300	*1500 *3300	7.53 24.49
4.5 m 15.0 ft	kg lb						*3600 *7850	2850 6100				*1500 *3250	*1500 *3250	8.23 26.91
3.0 m 10.0 ft	kg lb			*7650 *16,300	*7650 *16,300	*5150 *11,050	4400 9450	*4150 *9050	2700 5800	*2900 *5450	1800 3800	*1550 *3350	1400 3100	8.55 28.03
1.5 m 5.0 ft	kg lb			*5550 *13,350	*5550 *13,350	*6500 *14,000	4050 8650	4350 9350	2550 5500	3000 6400	1750 3650	*1700 *3650	1400 3000	8.54 28.02
Ground Line	kg lb			*5850 *13,500	*5850 *13,500	6700 14,400	3800 8100	4200 9050	2450 5200	2950 6450	1700 3650	*1900 *4200	1450 3150	8.20 26.91
-1.5 m -5.0 ft	kg lb	*4850 *10,850	*4850 *10,850	*8950 *20,400	7000 *15,050	6600 14,150	3700 7900	4150 8900	2400 5100			*2350 *5200	1700 3700	7.49 24.53
-3.0 m -10.0 ft	kg lb	*8400 *18,900	*8400 *18,900	*10,550 *22,800	7150 15,350	6650 14,200	3700 7950	4200 9000	2400 5150			*3300 *7350	2300 5150	6.26 20.37
-4.5 m -15.0 ft	kg lb			*8000 *17,000	7450 16,050	*5200 *11,400	3900 8600					*4900 *10,800	3750 8500	4.65 14.92

\* Limited by hydraulic capacity rather than tipping load. The above loads are in compliance with SAE hydraulic excavator lift capacity rating standard J1097. They do not exceed 87% of hydraulic lifting capacity or 75% of tipping capacity. Weight of all lifting accessories must be deducted from the above lifting capacities.















**R3.1 STICK** – 3100 mm (10'2")

**BUCKET** – 0.59 m<sup>3</sup> (0.78 yd<sup>3</sup>)

**UNDERCARRIAGE** – Long

**SHOES** – 600 mm (24") triple grouser

**BOOM** – 5100 mm (16'9")

	1.5 m (5.0 ft)		3.0 m (10.0 ft)		4.5 m (15.0 ft)		6.0 m (20.0 ft)		7.5 m (25.0 ft)				m ft	
														
7.5 m 25.0 ft	kg lb											*1400 *3150	*1400 *3150	6.85 22.07
6.0 m 20.0 ft	kg lb							*2850 *6250	*2850 *6250			*1300 *2900	*1300 *2900	7.98 26.01
4.5 m 15.0 ft	kg lb							*3250 *7050	2950 6250	*2350 *4500	1900 4050	*1300 *2850	*1300 *2850	8.64 28.27
3.0 m 10.0 ft	kg lb			*6350 *13,950	*6350 *13,950	*4550 *9850	4500 9700	*3850 *8300	2800 5950	3100 *6500	1850 3900	*1350 *3000	1300 2850	8.94 29.32
1.5 m 5.0 ft	kg lb			*9700 *21,250	7650 16,500	*6000 *12,950	4100 8800	4400 9450	2600 5550	3050 6450	1750 3750	*1500 *3250	1250 2750	8.93 29.32
Ground Line	kg lb			*6950 *15,900	*6950 *15,150	6750 14,450	3800 8150	4250 9050	2450 5250	2950 6300	1700 3600	*1750 *3800	1300 2900	8.62 28.27
-1.5 m -5.0 ft	kg lb	*4700 *10,450	*4700 *10,450	*8850 *20,100	6950 14,850	6550 14,050	3650 7850	4150 8850	2350 5050	2900 6400	1650 3600	*2150 *4700	1500 3300	7.95 26.04
-3.0 m -10.0 ft	kg lb	*7500 *16,850	*7500 *16,850	*11 100 *23,950	7000 15,000	6550 14,050	3650 7800	4100 8850	2350 5050			*2950 *6600	2000 4400	6.82 22.23
-4.5 m -15.0 ft	kg lb	*11 400 *25,800	*11 400 *25,800	*9100 *19,450	7250 15,550	*6050 *12,850	3750 8100					*2850 *6900	*2850 *6900	4.92 15.81

\* Limited by hydraulic capacity rather than tipping load. The above loads are in compliance with SAE hydraulic excavator lift capacity rating standard J1097. They do not exceed 87% of hydraulic lifting capacity or 75% of tipping capacity. Weight of all lifting accessories must be deducted from the above lifting capacities.

# 315C/315C L Hydraulic Excavators

## Reach Boom Lift Capacities

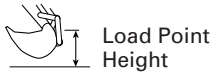

Load Point Height



Load at Maximum Reach



Load Radius Over Front



Load Radius Over Side













**R2.25 STICK** – 2250 mm (7'5")

**BUCKET** – 0.73 m<sup>3</sup> (0.95 yd<sup>3</sup>)

**UNDERCARRIAGE** – Standard

**SHOES** – 700 mm (28") triple grouser

**BOOM** – 5100 mm (16'9")

	1.5 m (5.0 ft)		3.0 m (10.0 ft)		4.5 m (15.0 ft)		6.0 m (20.0 ft)				m ft	
												
7.5 m 25.0 ft	kg lb									*1950 *4350	*1950 *4350	5.81 18.57
6.0 m 20.0 ft	kg lb						*2600 *5650	*2600 *5650	*1800 *3900	*1800 *3900		7.16 23.27
4.5 m 15.0 ft	kg lb				*4250 *9200	*4250 *9200	*3900 *8500	2800 5950	*1750 *3800	1700 3750		7.90 25.83
3.0 m 10.0 ft	kg lb		*8650 *18,300	8150 17,550	*5500 *11,850	4300 9200	3950 8450	2650 5700	*1800 *3950	1500 3300		8.23 26.99
1.5 m 5.0 ft	kg lb				6000 12,850	3950 8500	3800 8100	2550 5400	*1950 *4300	1450 3200		8.22 26.98
Ground Line	kg lb		*5450 *12,550	*5450 *12,550	5750 12,300	3750 8000	3650 7850	2400 5150	*2250 *4900	1550 3400		7.87 25.81
-1.5 m -5.0 ft	kg lb	*5250 *11,750	*5250 *11,750	*9500 *21,750	7000 15,000	5650 12,150	3650 7850	2350 5050	*2750 *6100	1850 4050		7.12 23.30
-3.0 m -10.0 ft	kg lb	*9600 *21,550	*9600 *21,550	*10,050 *21,700	7150 15,350	5750 12,300	3750 8000		*3150 *6800	2650 5900		5.79 18.80
-4.5 m -15.0 ft	kg lb			*7000 *15,400	*7000 *15,400				*5000 *11,300	4600 11,050		4.08 12.70

\* Limited by hydraulic capacity rather than tipping load. The above loads are in compliance with SAE hydraulic excavator lift capacity rating standard J1097. They do not exceed 87% of hydraulic lifting capacity or 75% of tipping capacity. Weight of all lifting accessories must be deducted from the above lifting capacities.















**R2.6 STICK** – 2600 mm (8'6")

**BUCKET** – 0.59 m<sup>3</sup> (0.78 yd<sup>3</sup>)

**UNDERCARRIAGE** – Standard

**SHOES** – 700 mm (28") triple grouser

**BOOM** – 5100 mm (16'9")

	1.5 m (5.0 ft)		3.0 m (10.0 ft)		4.5 m (15.0 ft)		6.0 m (20.0 ft)		7.5 m (25.0 ft)				m ft
													
7.5 m 25.0 ft	kg lb										*1700 *3750	*1700 *3750	6.28 20.16
6.0 m 20.0 ft	kg lb						*3100 *6250	3000 *6250			*1550 *3400	*1550 *3400	7.53 24.49
4.5 m 15.0 ft	kg lb						*3650 *7950	2850 6100			*1500 *3300	*1500 *3300	8.23 26.91
3.0 m 10.0 ft	kg lb		*7700 *16,350	*7700 *16,350	*5150 *11,100	4400 9450	4000 8600	2750 5850	2700 *5550	1800 3850	*1600 *3450	1450 3150	8.55 28.03
1.5 m 5.0 ft	kg lb		*5600 *13,500	*5600 *13,500	6050 13,000	4000 8650	3850 8200	2600 5500	2650 5650	1750 3700	*1700 *3750	1400 3050	8.54 28.02
Ground Line	kg lb		*5950 *13,700	*5950 *13,700	5800 12,400	3750 8100	3700 7900	2450 5250	2600 5700	1700 3700	*1950 *4300	1450 3200	8.20 26.91
-1.5 m -5.0 ft	kg lb	*4900 *11,000	*4900 *11,000	*9050 *20,600	6950 14,900	5650 12,150	3650 7850	2400 5100			*2400 *5300	1700 3750	7.49 24.53
-3.0 m -10.0 ft	kg lb	*8500 *19,050	*8500 *19,050	*10,600 *22,850	7100 15,200	5700 12,250	3700 7950	2400 5200			*3350 *7450	2350 5150	6.26 20.37
-4.5 m -15.0 ft	kg lb			*8050 *17,050	7400 15,900	*5200 *11,500	3900 8550				*4950 *10,850	3700 8500	4.65 14.92

\* Limited by hydraulic capacity rather than tipping load. The above loads are in compliance with SAE hydraulic excavator lift capacity rating standard J1097. They do not exceed 87% of hydraulic lifting capacity or 75% of tipping capacity. Weight of all lifting accessories must be deducted from the above lifting capacities.



# 315C/315C L Hydraulic Excavators

## Reach Boom Lift Capacities

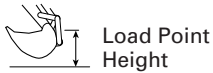

Load Point Height



Load at Maximum Reach



Load Radius Over Front



Load Radius Over Side















**R3.1 STICK** – 3100 mm (10'2")

**BUCKET** – 0.59 m<sup>3</sup> (0.78 yd<sup>3</sup>)

**UNDERCARRIAGE** – Standard

**SHOES** – 700 mm (28") triple grouser

**BOOM** – 5100 mm (16'9")

	1.5 m (5.0 ft)		3.0 m (10.0 ft)		4.5 m (15.0 ft)		6.0 m (20.0 ft)		7.5 m (25.0 ft)				m ft	
														
7.5 m 25.0 ft	kg lb											*1400 *3150	*1400 *3150	6.85 22.07
6.0 m 20.0 ft	kg lb						*2850 *6250	*2850 *6250				*1300 *2900	*1300 *2900	7.98 26.01
4.5 m 15.0 ft	kg lb						*3250 *7050	2900 6200	*2350 *4500	1900 4000	*1300 *2850	*1300 *2850	8.64 28.27	
3.0 m 10.0 ft	kg lb		*6350 *13,950	*6350 *13,950	*4550 *9850	4450 9600	*3850 *8300	2750 5900	2700 5800	1800 3850	*1350 *3000	1300 2850	8.94 29.32	
1.5 m 5.0 ft	kg lb		*9700 *21,250	7600 16,350	*6000 *12,950	4050 8750	3850 8200	2600 5500	2650 5600	1750 3700	*1500 *3250	1250 2700	8.93 29.32	
Ground Line	kg lb		*6950 *15,900	*6950 15,000	5800 12,400	3750 8050	3650 7850	2400 5150	2550 5450	1650 3550	*1750 *3800	1300 2850	8.62 28.27	
-1.5 m -5.0 ft	kg lb	*4700 *10,450	*4700 *10,450	*8850 *20,100	6850 14,700	5600 12,050	3600 7750	3550 7650	2350 5000	2500 5500	1650 3550	*2150 *4700	1500 3250	7.95 26.04
-3.0 m -10.0 ft	kg lb	*7500 *16,850	*7500 *16,850	*11 100 *23,950	6950 14,850	5600 12,000	3600 7750	3550 7650	2300 4950			*2950 *6600	1950 4350	6.82 22.23
-4.5 m -15.0 ft	kg lb	*11 400 *25,800	*11 400 *25,800	*9100 *19,450	7200 15,400	5750 12,350	3750 8050					*2850 *6900	*2850 *6900	4.92 15.81

\* Limited by hydraulic capacity rather than tipping load. The above loads are in compliance with SAE hydraulic excavator lift capacity rating standard J1097. They do not exceed 87% of hydraulic lifting capacity or 75% of tipping capacity. Weight of all lifting accessories must be deducted from the above lifting capacities.













**R2.25 STICK** – 2250 mm (7'5")

**BUCKET** – 0.73 m<sup>3</sup> (0.95 yd<sup>3</sup>)

**UNDERCARRIAGE** – Long

**SHOES** – 700 mm (28") triple grouser

**BOOM** – 5100 mm (16'9")

	1.5 m (5.0 ft)		3.0 m (10.0 ft)		4.5 m (15.0 ft)		6.0 m (20.0 ft)				m ft	
												
7.5 m 25.0 ft	kg lb									*1950 *4350	*1950 *4350	5.81 18.57
6.0 m 20.0 ft	kg lb						*2600 *5650	*2600 *5650	*1800 *3900	*1800 *3900		7.16 23.27
4.5 m 15.0 ft	kg lb					*4250 *9200	*4250 *9200	*3900 *8500	2850 6100	*1750 *3800	*1750 *3800	7.90 25.83
3.0 m 10.0 ft	kg lb		*8650 *18,300	8300 17,900	*5500 *11,850	4400 9400	*4400 *9550	2750 5850	*1800 *3950	1550 3400		8.23 26.99
1.5 m 5.0 ft	kg lb				*6800 *14,600	4050 8650	4400 9450	2600 5550	*1950 *4300	1500 3300		8.22 26.98
Ground Line	kg lb		*5450 *12,550	*5450 *12,550	6800 14,550	3800 8200	4300 9150	2500 5300	*2250 *4900	1600 3500		7.87 25.81
-1.5 m -5.0 ft	kg lb	*5250 *11,750	*5250 *11,750	*9500 *21,750	7150 15,300	6700 14,350	3750 8050	4250 9050	2450 5200	*2750 *6100	1900 4150	7.12 23.30
-3.0 m -10.0 ft	kg lb	*9600 *21,550	*9600 *21,550	*10 050 *21,700	7300 15,700	6750 14,500	3800 8200			*3150 *6800	2700 6050	5.79 18.80
-4.5 m -15.0 ft	kg lb			*7000 *15,400	*7000 *15,400					*5000 *11,300	4700 11,250	4.08 12.70

\* Limited by hydraulic capacity rather than tipping load. The above loads are in compliance with SAE hydraulic excavator lift capacity rating standard J1097. They do not exceed 87% of hydraulic lifting capacity or 75% of tipping capacity. Weight of all lifting accessories must be deducted from the above lifting capacities.

# 315C/315C L Hydraulic Excavators

## Reach Boom Lift Capacities

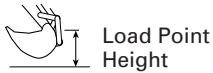

Load Point Height



Load at Maximum Reach



Load Radius Over Front



Load Radius Over Side















**R2.6 STICK** – 2600 mm (8'6")

**BUCKET** – 0.73 m<sup>3</sup> (0.95 yd<sup>3</sup>)

**UNDERCARRIAGE** – Long

**SHOES** – 700 mm (28") triple grouser

**BOOM** – 5100 mm (16'9")

	1.5 m (5.0 ft)		3.0 m (10.0 ft)		4.5 m (15.0 ft)		6.0 m (20.0 ft)		7.5 m (25.0 ft)				m ft	
														
7.5 m 25.0 ft	kg lb											*1650 *3650	*1650 *3650	6.28 20.16
6.0 m 20.0 ft	kg lb						*2900 *5900	*2900 *5900				*1500 *3300	*1500 *3300	7.53 24.49
4.5 m 15.0 ft	kg lb						*3600 *7850	2900 6150				*1500 *3250	*1500 *3250	8.23 26.91
3.0 m 10.0 ft	kg lb		*7650 *16,300	*7650 *16,300	*5150 *11,050	4450 9550	*4150 *9050	2750 5900	*2900 *5450	1800 3850	*1550 *3350	1450 3150	8.55 28.03	
1.5 m 5.0 ft	kg lb		*5550 *13,350	*5550 *13,350	*6500 *14,000	4100 8750	4400 9450	2600 5550	3050 6500	1750 3750	*1700 *3650	1400 3050	8.54 28.02	
Ground Line	kg lb		*5850 *13,500	*5850 *13,500	6800 14,550	3850 8250	4300 9150	2450 5300	3000 6550	1700 3750	*1900 *4200	1450 3200	8.20 26.91	
-1.5 m -5.0 ft	kg lb	*4850 *10,850	*4850 *10,850	*8950 *20,400	7100 15,250	6700 14,300	3750 8000	4200 9000	2400 5150		*2350 *5200	1700 3750	7.49 24.53	
-3.0 m -10.0 ft	kg lb	*8400 *18,900	*8400 *18,900	*10,550 *22,800	7250 15,550	6700 14,400	3750 8100	4250 9100	2450 5250		*3300 *7350	2350 5250	6.26 20.37	
-4.5 m -15.0 ft	kg lb			*8000 *17,000	7550 16,250	*5200 *11,400	3950 8700				*4900 *10,800	3800 8600	4.65 14.92	

\* Limited by hydraulic capacity rather than tipping load. The above loads are in compliance with SAE hydraulic excavator lift capacity rating standard J1097. They do not exceed 87% of hydraulic lifting capacity or 75% of tipping capacity. Weight of all lifting accessories must be deducted from the above lifting capacities.















**R3.1 STICK** – 3100 mm (10'2")

**BUCKET** – 0.59 m<sup>3</sup> (0.78 yd<sup>3</sup>)

**UNDERCARRIAGE** – Long

**SHOES** – 700 mm (28") triple grouser

**BOOM** – 5100 mm (16'9")

	1.5 m (5.0 ft)		3.0 m (10.0 ft)		4.5 m (15.0 ft)		6.0 m (20.0 ft)		7.5 m (25.0 ft)				m ft	
														
7.5 m 25.0 ft	kg lb											*1400 *3150	*1400 *3150	6.85 22.07
6.0 m 20.0 ft	kg lb						*2850 *6250	*2850 *6250				*1300 *2900	*1300 *2900	7.98 26.01
4.5 m 15.0 ft	kg lb						*3250 *7050	2950 6350	*2350 *4500	1950 4100	*1300 *2850	*1300 *2850	8.64 28.27	
3.0 m 10.0 ft	kg lb		*6350 *13,950	*6350 *13,950	*4550 *9850	4550 9800	*3850 *8300	2800 6000	3150 *6500	1850 3950	*1350 *3000	1350 2900	8.94 29.32	
1.5 m 5.0 ft	kg lb		*9700 *21,250	7750 16,650	*6000 *12,950	4150 8950	4450 9550	2650 5650	3050 6550	1800 3800	*1500 *3250	1300 2800	8.93 29.32	
Ground Line	kg lb		*6950 *15,900	*6950 *15,350	6800 14,600	3850 8250	4300 9200	2500 5300	3000 6400	1700 3650	*1750 *3800	1350 2950	8.62 28.27	
-1.5 m -5.0 ft	kg lb	*4700 *10,450	*4700 *10,450	*8850 *20,100	7000 15,050	6650 14,250	3700 7950	4200 8950	2400 5100	*2950 *6450	1650 3650	*2150 *4700	1550 3350	7.95 26.04
-3.0 m -10.0 ft	kg lb	*7500 *16,850	*7500 *16,850	*11,100 *23,950	7100 15,200	6650 14,200	3700 7900	4200 8950	2400 5100		*2950 *6600	2000 4450	6.82 22.23	
-4.5 m -15.0 ft	kg lb	*11,400 *25,800	*11,400 *25,800	*9100 *19,450	7350 15,750	*6050 *12,850	3800 8200				*2850 *6900	*2850 *6900	4.92 15.81	

\* Limited by hydraulic capacity rather than tipping load. The above loads are in compliance with SAE hydraulic excavator lift capacity rating standard J1097. They do not exceed 87% of hydraulic lifting capacity or 75% of tipping capacity. Weight of all lifting accessories must be deducted from the above lifting capacities.